

## SENSOR WITH RGB LED EMISSION AND PLASTIC HOUSING



- *High resolution and RGB LED emission with automatic colour selection*
- *Very fast switching frequency and low response time*
- *Easy sensor setting by means of two pushbuttons Mark/Bkgd*
- *Sturdy plastic housing with standard dimensions and fixing holes*

## TL50 SERIES

**TL50** contrast sensor line offers the best solution for all the applications where a cost reduction is requested, without compromising the excellent detection performances. The optimised optics of these sensors, the RGB LED emission with automatic colour selection and the very fine resolution, allow the detection of the weakest contrast of colours or grayscale between mark and background, or between different objects or surfaces.

The high resolution is not a limit for the detection speed, reaching 33 ms response time and 15 kHz switching frequency.

Thanks to only two pushbuttons 'Mark' and 'Bkgd' for the different signals acquisition, the automatic threshold setting is very easy and accurate.

**TL50** sensors can find typical applications on packaging machinery for food, cosmetic or pharmaceutical goods, for the detection of print registration marks, labels or other references on plastic films or packages, even on transparent material.

Thanks to the compact dimensions and multiple fixing holes with metallic inserts present in standard positions, the sturdy ABS plastic housing is fully compatible and can replace the most of traditional contrast sensors, also offering an appreciable cost reduction.

The special PMMA plastic lens, fixable either in axial or lateral position, is suitable for the sensor use in the food industry, where the presence of glass parts must be avoided.

## SETTING

The acquisition of the mark and background signals is made by pressing the MARK and BKGD pushbuttons.

The switching threshold level is set automatically between the mark and background values.

The Dark/Light operating mode is selected by the sensor on the ground of the lower or higher mark reflectivity with respect to the background.

When the green LED turns on the setting has been successfully completed and the sensor is ready, whereas the LED blinking indicates a setting failure or an insufficient contrast between mark and background.

## DIMENSIONS

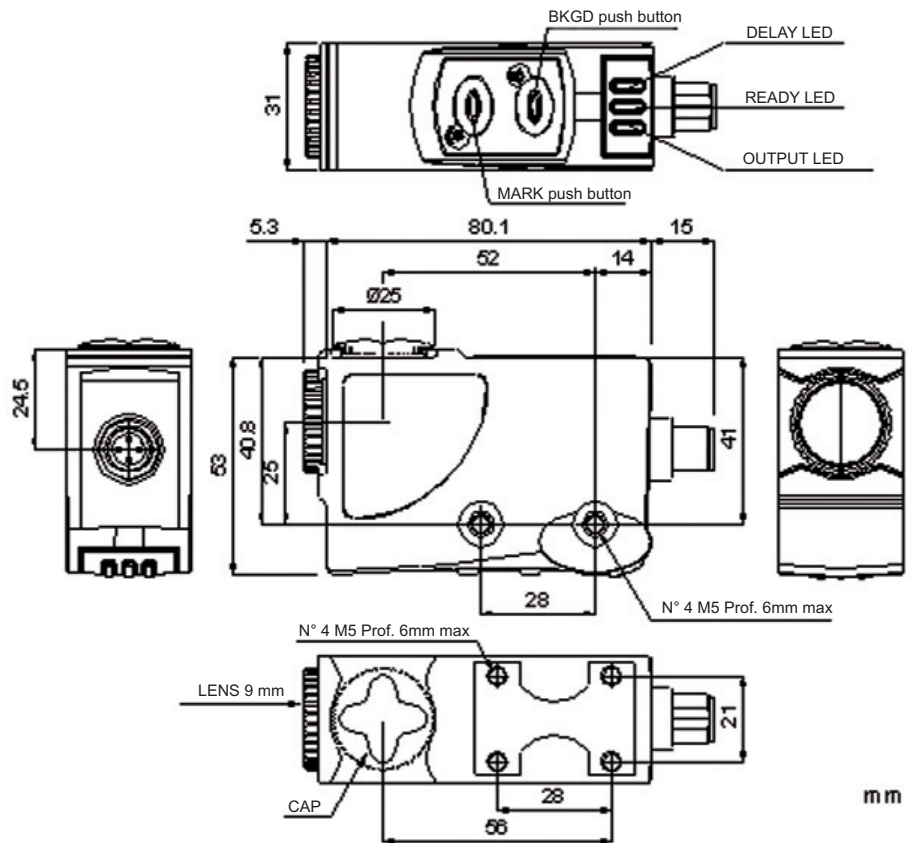

## INDICATORS AND PUSH-BUTTONS

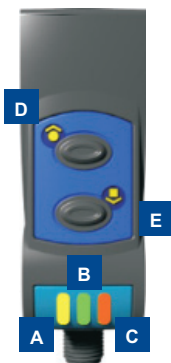

- |                            |                           |
|----------------------------|---------------------------|
| <b>A</b> yellow OUTPUT LED | <b>D</b> MARK push button |
| <b>B</b> green READY LED   | <b>E</b> BKGD push button |
| <b>C</b> orange DELAY LED  |                           |

## ACCESSORIES

For dedicated accessories refer to the ACCESSORIES section of this catalogue.

Refer also to Connectors of the General Catalogue.

## CONNECTIONS

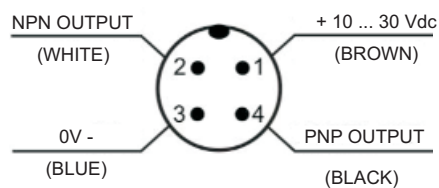



## TECHNICAL DATA

<b>Power supply:</b>	10...30 Vdc <sup>1</sup> , reverse polarity protection
<b>Consumption :</b>	50 mA max @ 24 Vdc
<b>Light emission:</b>	RGB LED (465 nm blue, 520 nm green, 630 nm red)
<b>Spot dimension:</b>	1.5 x 5 mm @ 9 mm
<b>Operating distance:</b>	9 mm
	± 3 mm
<b>Setting:</b>	Automatic (MARK push button, BKGD push button)
<b>Indicators:</b>	OUTPUT LED (yellow) / READY RED (green) / DELAY LED (orange)
<b>Output type:</b>	PNP and NPN bipolar outputs
<b>Output current:</b>	100 mA max.
<b>Saturation voltage:</b>	≤2 V
<b>Response time:</b>	33 μs
<b>Switching frequency:</b>	15 kHz
<b>Dark/Light selection</b>	Automatic
<b>Timing function:</b>	0 ... 20 ms selectable
<b>Connections:</b>	connector M12 4 poles <sup>2</sup>
<b>Insulation:</b>	>20 MΩ 500 Vdc
<b>Mechanical protection:</b>	IP67
<b>Protection devices:</b>	A, B <sup>3</sup>
<b>Housing material:</b>	ABS
<b>Lens material:</b>	PMMA
<b>Weight:</b>	90 g. max.
<b>Operating temperature:</b>	-10 ... 55 °C
<b>Storage temperature:</b>	-20 ... 70 °C
<b>Reference standard:</b>	EN 60947-5-2

## TECHNICAL NOTES

<sup>1</sup> Average life of 100.000 h with  $T_A = +25\text{ °C}$

<sup>2</sup> Connector block rotatable on 4 positions

<sup>3</sup> A - reverse polarity protection

B - overload and short-circuit protection

## DETECTION DIAGRAMS

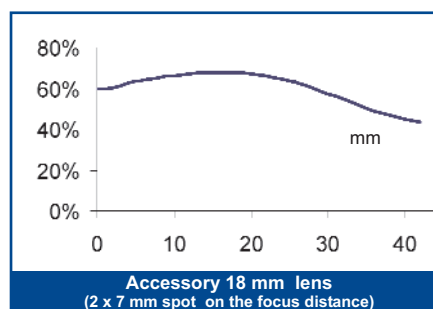
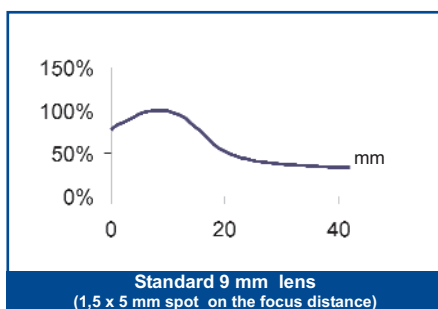

## MODEL SELECTION AND ORDER INFORMATION

MODEL	OPERATING DISTANCE	ORDER N°
TL50-W-815	10 - 20 mm	954651000

## ACCESSORY LENSES

## DIMENSIONS

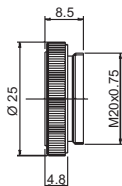

Lens No.9 glass

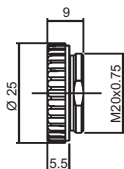

Lens No.9 PMMA

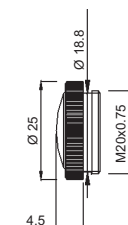

Lens 18 mm glass

mm

## ACCESSORY SELECTION AND ORDER INFORMATION

MODEL	DESCRIPTION	ORDER N°
Lens No.9 glass	glass lens with 9 mm focus	95ACC1020
Lens No.9 PMMA	plastic lens with 9 mm focus	95ACC2540
Lens No.18 glass	glass lens with 18 mm focus	95ACC1030

Please refer also to *Sensor Accessories*



Distributed by:

### HEADQUARTERS

**DATASENSOR SpA**  
via Lavino, 265 - 40050 Monte San Pietro, BO - Italy  
Tel. +39 051/6765611 • Fax +39 051/6759324  
[www.datasensor.com](http://www.datasensor.com) • e-mail [info@datasensor.com](mailto:info@datasensor.com)

DATASENSOR SpA endeavours to continuously improve and renew its products; for this reason the technical data and contents of this catalogue may undergo variations without prior notice. For correct installation and use DATASENSOR SpA can guarantee only the data indicated in the instruction manual supplied with the products.