

MINIATURE AMPLIFIED SENSORS

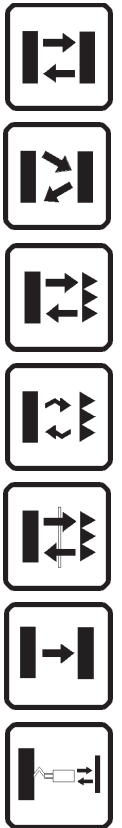

- *Miniature housing with axial or lateral optics*
- *Wide range of optic functions including fibre versions*
- *Sensitivity adjustment and stability LED*
- *NPN/PNP and dark/light configurable output*



S3 SERIES

The photoelectric sensors of the **S3** series are characterised by particularly compact dimensions still offering excellent performances and a wide variety of models.

The wide range of optic functions include diffuse proximity with distance adjustable up to 10 cm or 50 cm, or 12 mm fixed focus proximity. The retroreflex versions reach 3 m and are also available in the polarised version suitable for detecting shiny objects, or low hysteresis models to detect transparent objects. The 5 m through beam models complete the series, together with versions for the different fibre-optics available as accessories.

All models offer trimmer sensitivity adjustment and LED stability indicator; the axial and lateral optics guarantee the same performances. Maximum installation versatility and use are obtained thanks to the configurable output and miniature housing.



TECHNICAL DATA

Power supply:	10 ... 30 Vdc, reverse polarity protection
Consumption:	30 mA max.
Light emission:	infrared 880 nm LED red 660 nm LED (B2, D12, E1 vers.)
Diffuse proximity operating distance:	0 ... 10 cm (C10 vers.) 0 ... 50 cm (C50 vers.)
Fixed focus operating distance:	12 mm with 1 mm spot (D12 vers.)
Retroreflex operating distance:	0.1 ... 2.5 m (on R2)
Polarised retroreflex operating distance: ..	0.1 ... 2 m (on R2)
Retroreflex for transparents op. distance: ..	0.2 ... 0.8 m (on R2)
Through beam operating distance:	0 ... 5 m
Operating distance with fibre-optics:	33 mm proximity (with OF-18-ST) 110 mm through beam (with OF-19-ST) <i>refer to OF series for other fibres</i>
Setting:	sensitivity trimmer
Indicators:	red OUTPUT LED green STABILITY LED red POWER LED (G5 vers.)
Output type:	PNP (connector vers.) NPN/PNP configurable (cable vers.)
Saturation voltage:	1.5 V max.
Output current:	100 mA max., short-circuit protection
Response time:	1 ms max. 2 ms (F vers.)
Switching frequency:	500 Hz max. 250 Hz max. (F vers.)
Operating mode:	dark/light configurable
Auxiliary functions:	'test +' and 'test -' inputs (G vers.)
Connection:	M8 4-pole connector 2 m Ø 5 mm cable
Electrical protection:	class 2
Mechanical protection:	IP66
Housing material:	ABS
Lens material:	PMMA plastic
Weight:	20 g max. (connector vers.) 90 g max. (cable vers.)
Operating temperature:	-25 ... +55°C
Storage temperature:	-25 ... +70°C
Reference standard:	EN 60947-5-2
Certifications:	CE

DETECTION DIAGRAMS

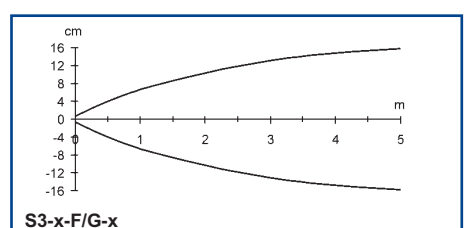
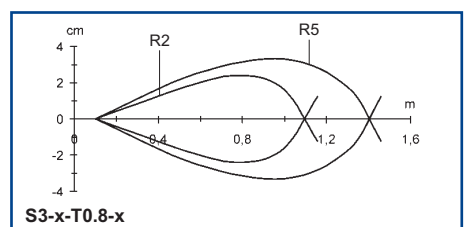
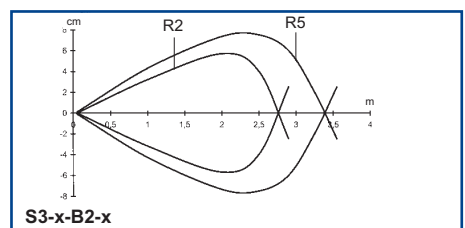
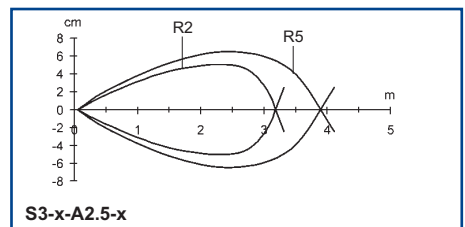
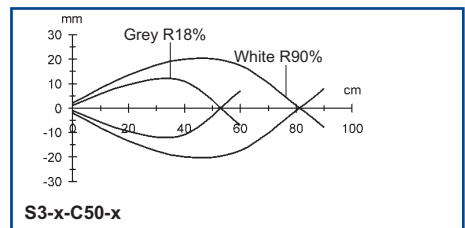
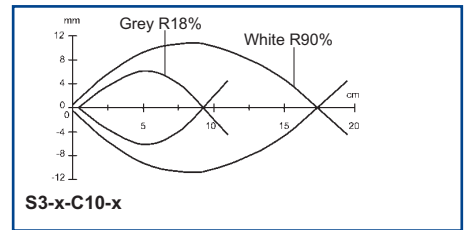

The operating distances indicate the detection distance with excess gain 2.

The detection diagrams indicate the typical operating distance with excess gain 1.



CONNECTIONS

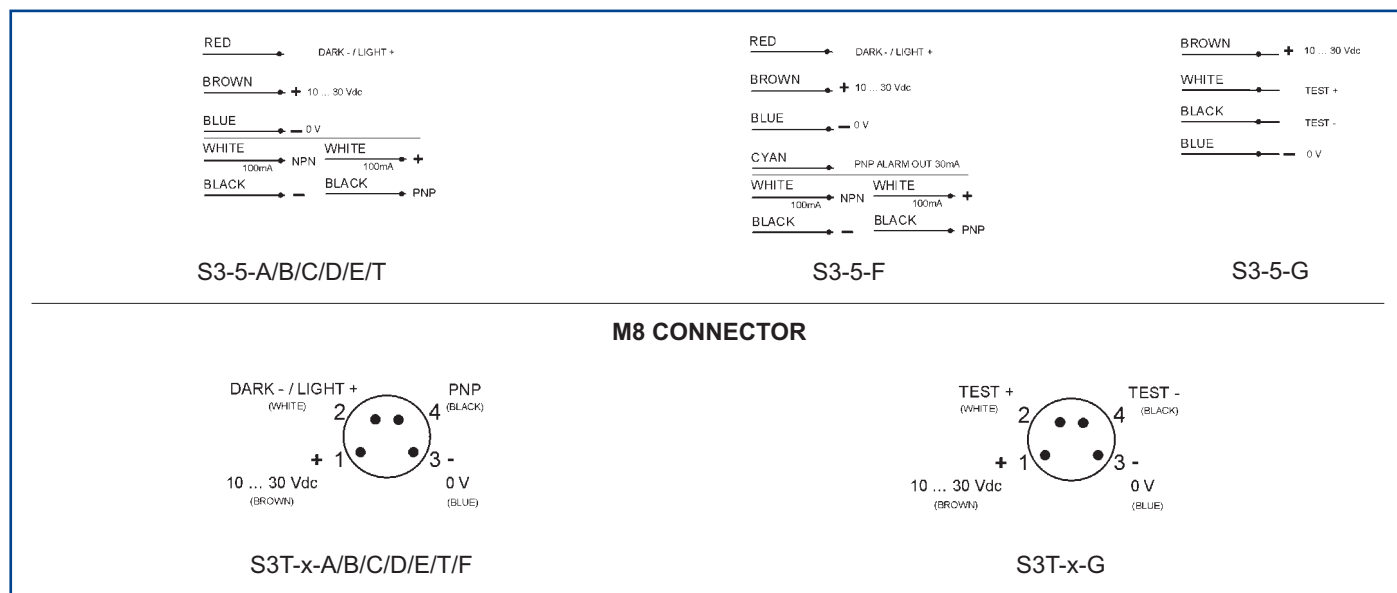

DIMENSIONS

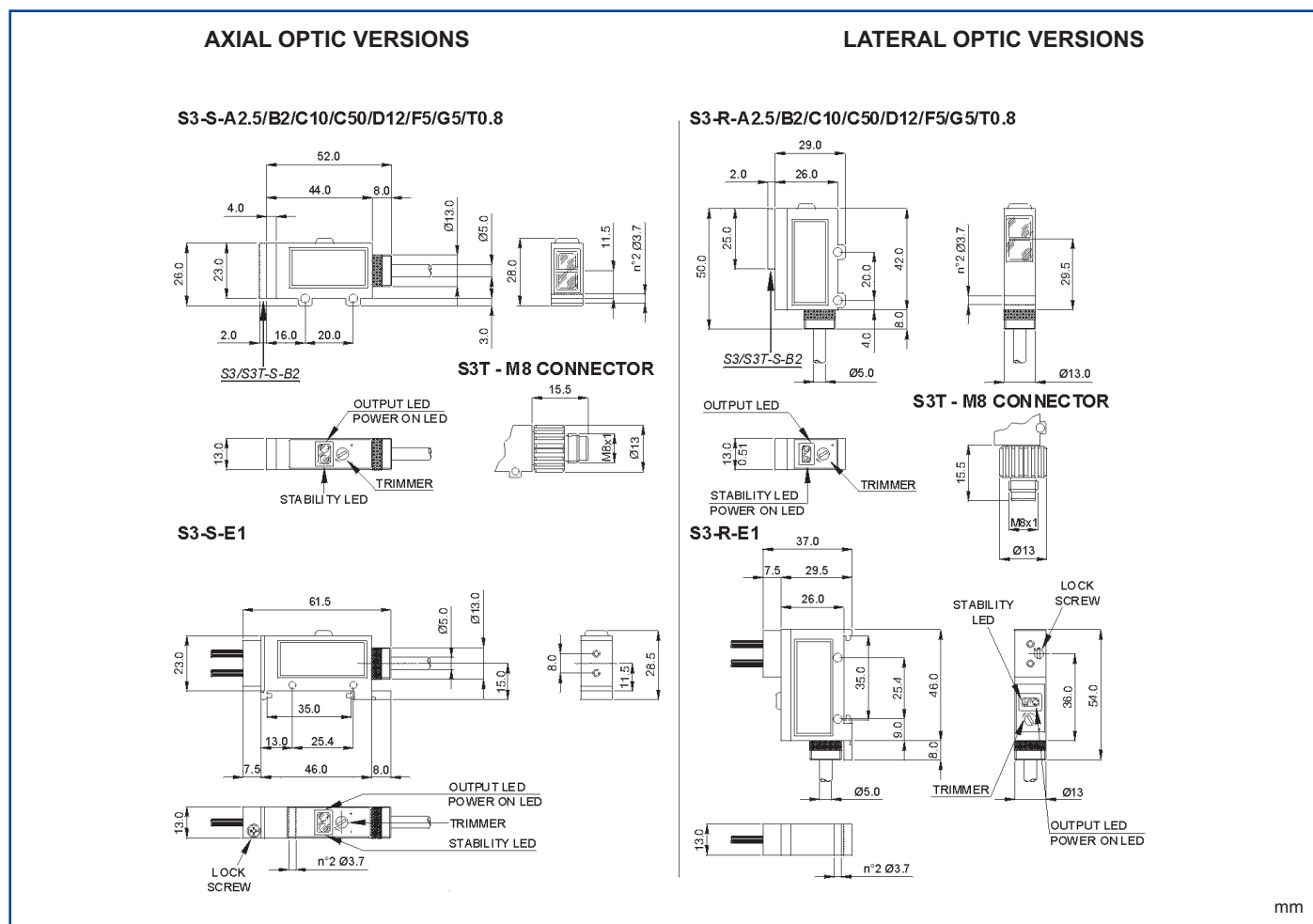



MODEL SELECTION AND ORDER INFORMATION

MODEL	FUNCTION	OPTICS	CONNECTION	OUTPUT	CODE N°
S3-R-C10	diffuse proximity	lateral	cable	NPN/PNP	S936530005
S3T-R-C10-P	diffuse proximity	lateral	M8 connector	PNP	S939730201
S3-S-C10	diffuse proximity	axial	cable	NPN/PNP	S936530004
S3T-S-C10-P	diffuse proximity	axial	M8 connector	PNP	S939730200
S3-R-C50	diffuse proximity	lateral	cable	NPN/PNP	S936530001
S3T-R-C50-P	diffuse proximity	lateral	M8 connector	PNP	S939530201
S3-S-C50	diffuse proximity	axial	cable	NPN/PNP	S936530000
S3T-S-C50-P	diffuse proximity	axial	M8 connector	PNP	S939530200
S3-R-D12	fixed focus proximity	lateral	cable	NPN/PNP	S936620001
S3T-R-D12-P	fixed focus proximity	lateral	M8 connector	PNP	S939620201
S3-S-D12	fixed focus proximity	axial	cable	NPN/PNP	S936620000
S3T-S-D12-P	fixed focus proximity	axial	M8 connector	PNP	S939620200
S3-R-A2,5	retroreflex	lateral	cable	NPN/PNP	S936330001
S3T-R-A2,5-P	retroreflex	lateral	M8 connector	PNP	S939330201
S3-S-A2,5	retroreflex	axial	cable	NPN/PNP	S936330000
S3T-S-A2,5-P	retroreflex	axial	M8 connector	PNP	S939330200
S3-R-B2	polarised retroreflex	lateral	cable	NPN/PNP	S936420001
S3T-R-B2-P	polarised retroreflex	lateral	M8 connector	PNP	S939420201
S3-S-B2	polarised retroreflex	axial	cable	NPN/PNP	S936420000
S3T-S-B2-P	polarised retroreflex	axial	M8 connector	PNP	S939420200
S3-R-T0,8	retroreflex for transp.	lateral	cable	NPN/PNP	S936330009
S3T-R-T0,8-P	retroreflex for transp.	lateral	M8 connector	PNP	S939330209
S3-S-T0,8	retroreflex for transp.	axial	cable	NPN/PNP	S936330008
S3T-S-T0,8-P	retroreflex for transp.	axial	M8 connector	PNP	S939330208
S3-R-E1	fibre-optic conn.	lateral	cable	NPN/PNP	S936820001
S3T-R-E1-P	fibre-optic conn.	lateral	M8 connector	PNP	S939820201
S3-S-E1	fibre-optic conn.	axial	cable	NPN/PNP	S936820000
S3T-S-E1-P	fibre-optic conn.	axial	M8 connector	PNP	S939820200
S3-R-F5	receiver	lateral	cable	NPN/PNP	S936200001
S3T-R-F5-P	receiver	lateral	M8 connector	PNP	S939200201
S3-S-F5	receiver	axial	cable	NPN/PNP	S936200000
S3T-S-F5-P	receiver	axial	M8 connector	PNP	S939200200
S3-R-G5	emitter	lateral	cable	-	S936130001
S3T-R-G5	emitter	lateral	M8 connector	-	S939130901
S3-S-G5	emitter	axial	cable	-	S936130000
S3T-S-G5	emitter	axial	M8 connector	-	S939130900

Distributed by:

HEADQUARTERS

DATASENSOR SpA

via Lavino, 265 - 40050 Monte San Pietro, BO - Italy
 Tel. +39 051/6765611 • Fax +39 051/6759324
www.datasensor.com • e-mail info@datasensor.com

Datasensor SpA endeavours to continuously improve and renew its products; for this reason the technical data and contents of this catalogue may undergo variations without prior notice. For correct installation and use Datasensor SpA can guarantee only the data indicated in the instruction manual supplied with the products.

UNIVERSAL MINI SENSORS