



INCREMENTAL ENCODER GENERAL DESCRIPTION



Working principle

An encoder is a rotational transducer converting an angular movement into a series of electrical digital pulses. If associated to racks or endless screws, these generated pulses can be used to control angular or linear movements. During rotation, electrical signals can be elaborated by numerical controls (CNC), programmable logic controls (PLC), control systems, etc. Main applications of these transducers are: machinery, robots, motor feedback, measure and control devices. In Eltra's encoders the angular movement transduction is based on the photoelectric scanning principle. The reading system is based on the rotation of the radial graduated disk formed by opaque windows and transparent ones alternated. The system is perpendicularly illuminated by an infrared light source. The light projects the disk image on the receivers surface which are covered by a grating called collimator having the same disk steps. The receivers transduce the light variation occurring with the disk shifting, converting them into their corresponding electrical variations. Electrical signals raised to generate squared pulses without any interference must be electronically processed. The reading system is always carried out in differential modality, in order to compare different signals nearly identical but out of phase for 180 electrical degrees. That in order to increase quality and stability of output signals. The reading is designed comparing the difference between the two channels eliminating the disturb note as "shifted common way" because signals are overlapped in equal way on every kind of wave.

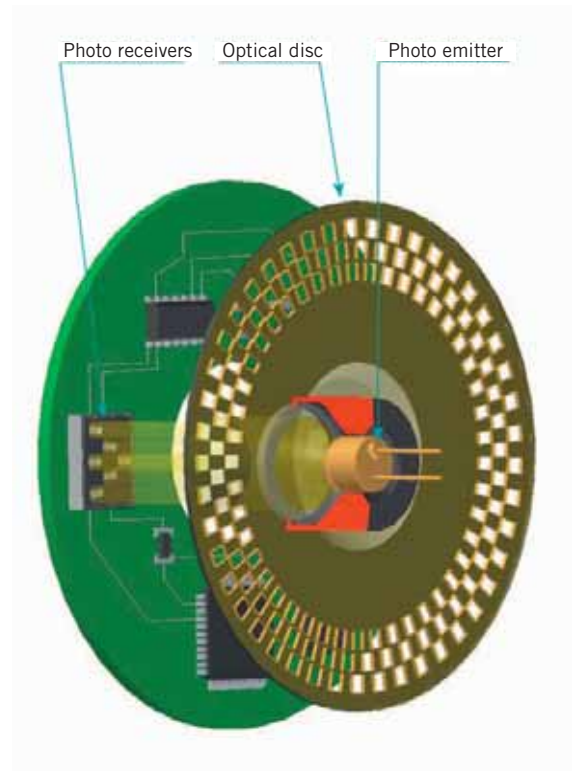

Incremental encoders

The incremental encoder usually gives two types of squared waves out of phase for 90 electrical degrees. They are usually called channel A and B. The first channel gives information about the rotation speed while the second, basing on the states sequence produced by the two signals, provides the sense of rotation. A further signals, called Z or zero channel, is also available. It gives the absolute zero position of the encoder shaft. This signal is a squared impulse with the phase and the width centred on A channel.

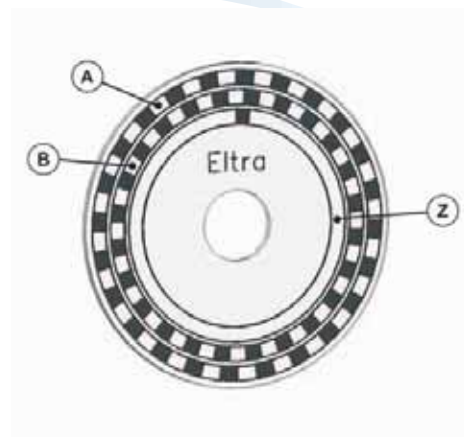

The incremental encoder precision depends on mechanical and electrical factors. These errors could be: grating division, disk eccentricity, bearings eccentricity, electronic reading and optic inaccuracy. The measurement unit to define encoder precision is the electrical degree. It determinates the division of the impulse generated by the encoder: 360 electric degrees correspond to the mechanical rotation of the shaft which is necessary to carry out a complete cycle. To know how many mechanical degrees correspond to electrical 360° the following formula has to be applied:

$$\text{Electrical } 360^\circ = \frac{\text{Mechanic } 360^\circ}{n^\circ \text{ pulse / turn}}$$

The encoder division error is given from the maximum shifting shown in the electrical degrees of two consecutive surges. This error exists in any encoder and is due to the above mentioned factors. For Eltra's encoders this error is included in electrical +/- 25° Max in whatever allowed condition, which corresponds to a shifting of +/- 7 % from the nominal value. Regarding the 90 electrical degrees shifting between the two channels, it differs by +/- 35 electrical degrees Max. It corresponds to +/- 10 %.

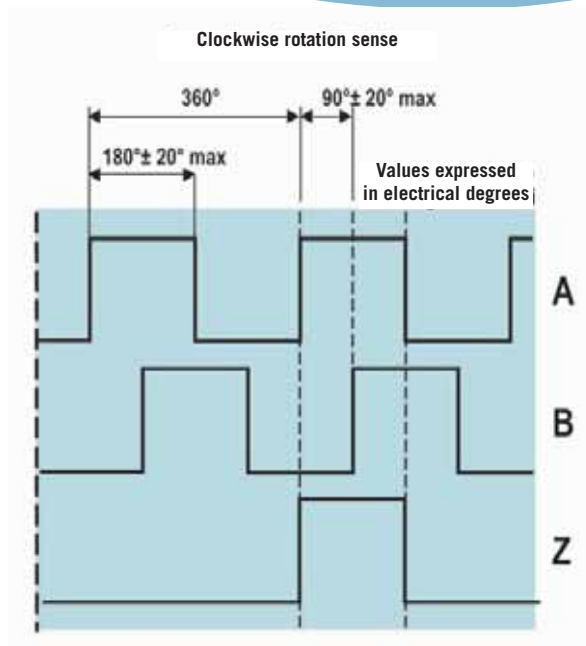

Graphic representation of the A, B and Z incremental signals.

Incremental encoder with integrated commutation phases

In addition to the above mentioned encoders, there are others which integrate additional electrical output signals. These are the incremental encoders with integrated commutation signals, used as motor feedback. These additional signals simulate the Hall phases generally present in the commutation motors (brushless type) and usually designed with magnetic sensors. In Eltra's encoders these commutation signals are optically generated and presented as three squared waves, shifted by 120° electrical degrees. These signals will be used by the driver control to the motor in order to generate the correct voltages phase to determinate the correct rotation. These commutation pulses can be repeated many times within one mechanical rotation because they directly depend on the poles number in the connected motor. So we have commutation phases for motors of 4, 6 or more poles.

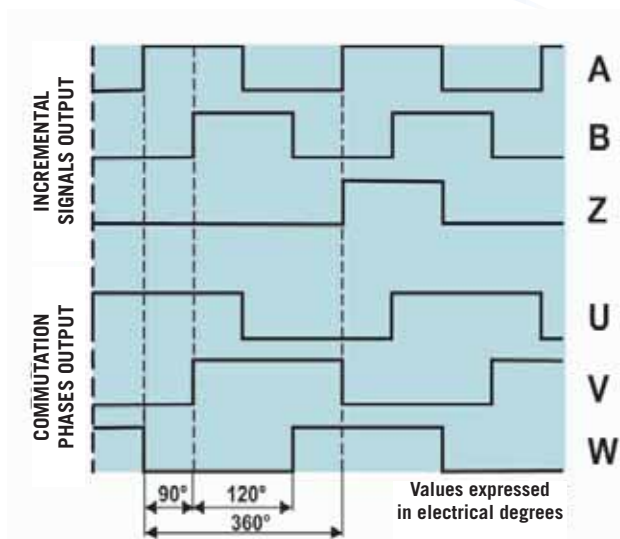

Graphic representation of A, B and Z incremental signals with commutation U, V and W.

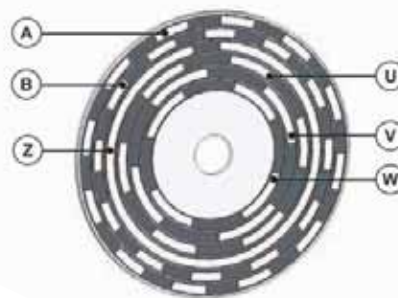

MAIN FEATURES

Encoders for industrial environments with hollow shaft, aluminum lid and insulated bearings, with excellent mechanical strength and the possibility of high radial and axial load.

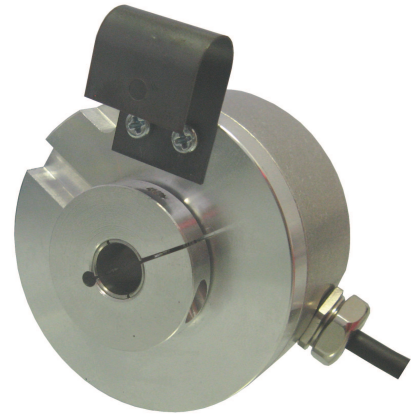

ORDERING CODE

EL 63 GBM 512 Z 5/28 N 8 X 3 PR . XXX

SERIES incremental encoder series EL	SIZE external dimensions 63.5 mm 63	TYPE blind hollow shaft, metal cover, screw fixing and anti-rotation pin GBM blind hollow shaft, metal cover, screw fixing and anti-rotation spring FBM	RESOLUTION ppr from 1 to 2048	ZERO PULSE without zero pulse S with zero pulse Z	POWER SUPPLY 5 ... 28 V DC 5/28 <i>line driver available only with 5 V DC or 8 ... 24 V DC power supply</i>	VARIANT XXX custom version	OUTPUT TYPE PR cable output radial with SKINTOP (standard length 1.5 m)	MAX ROTATION SPEED 3 3000 rpm	ENCLOSURE RATING S IP 65	HOLLOW SHAFT 8 mm 10 mm 12 mm 14 mm 15 mm	ELECTRONIC INTERFACE N NPN C NPN open collector P push-pull L line driver
---	--	--	--	--	---	---	---	--	---	---	--

EL 63 GBM

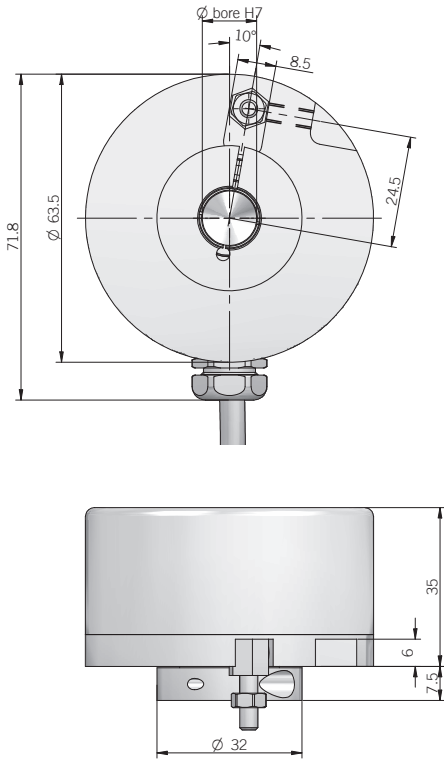

EL 63 FBM

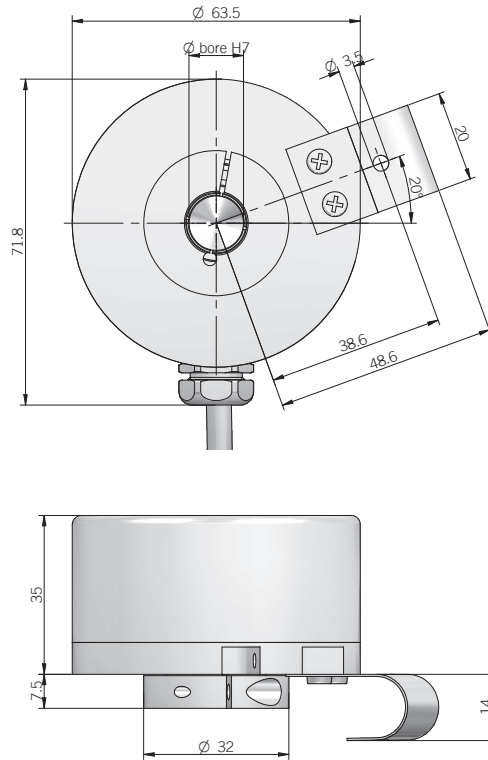

Electrical specifications

Resolution	from 1 to 2048 ppr
Power supply	5 ... 28 V DC <i>(line driver available only with 5 V DC or 8 ... 24 V DC)</i>
Current consumption without load	100 mA max
Max load current	50 mA for channel 20 mA for channel (line driver)
Signal pattern	B follows A with clockwise rotation (shaft view)
Output type for incremental signals	NPN / NPN open collector / push-pull / line driver
Max output frequency	300 kHz
Electromagnetic compatibility	IEC 61000-6-2 IEC 61000-6-3

Mechanical specifications

Shaft diameter	8 / 10 / 12 / 14 / 15 mm
Enclosure rating	IP 65 (IEC 60529)
Max rotation speed	3000 rpm
Shock	50 G, 11 ms (IEC 60068-2-27)
Vibration	10 G, 10 ... 2000 Hz (IEC 60068-2-6)
Bearing life	10 ⁹ revolutions
Bearings	2 ball bearings insulated
Shaft material	stainless steel UNI X10CrNiS1809
Body material	aluminum UNI 9002/5
Housing material	aluminum UNI 9002/5
Operating temperature	-20° ... +70°C
Storage temperature	-25° ... +70°C
Weight	300 g



PRECISION ELASTIC COUPLINGS



Elastic Couplings

Ordering Code

ELTRA elastic precision couplings are essential parts for the transmission of rotational motion to the encoder shaft. Couplings are designed in aluminium alloy (type D11S A.A 2011) and are composed by a cylindrical body on which there is an helicoidal groove.

Main characteristics are:

- torsional rigidity
- ability to support slight shaft misadjustments
- ability to absorb small axial shift of the shaft.

ELTRA elastic couplings have also a perfect balancing of the rotating body. They don't have critical points subjects to breakage and are completely frictionless. Moreover, they perfectly transmit the rotation motion, even in case of axial misadjustment and misalignment. Our coupling do not require any type of maintenance. The internal drain allows the coupling between the shafts from a minimum of 0.5mm to a maximum of 6.12mm (note "F" quota).

NOTE: Elastic Coupling can be supplied with different coupling diameters. Eg: d1=8mm, d2=10mm. In this case the identification code should be: G25A8/10.

G 25 A 6 / 8

Precision elastic Coupling G

Coupling size

- (see table) 16
- (see table) 20
- (see table) 25
- (see table) 30

Shaft dowel fixing

A

∅ hole "d1"

- ∅ 6 6
- ∅ 8 8
- ∅ 9.52 (3/8") 9
- ∅ 10 10

∅ hole "d2"

- ∅ 6 6
- ∅ 8 8
- ∅ 9.52 (3/8") 9
- ∅ 10 10

NOTE: if d1 is equal to d2 that is not necessary

SPECIAL PRODUCTS

ELASTIC COUPLINGS

Construction data and specifications

Type of material:
Aluminium

NOTE: for non standard (d1-d2) please contact our offices.



Standard Couplings	De	L	d1 = d2	A	B	M	E	F	Twisting moment
G 16 A 4	∅ 16	20 ^{+0.1} / _{-0.1}	∅ 4H7 ^{+0.012} / ₀	6	8	M3	7	6	0.25 Nm
G 20 A 6	∅ 20	20 ^{+0.1} / _{-0.1}	∅ 6H7 ^{+0.012} / ₀	6	8	M3	7	6	0.25 Nm
G 25 A 8	∅ 25	25 ^{+0.1} / _{-0.1}	∅ 8H7 ^{+0.015} / ₀	7	11	M4	8	9	0.4 Nm
G 25 A 9	∅ 25	25 ^{+0.1} / _{-0.1}	∅ 9.52H7 ^{+0.015} / ₀	7	11	M4	8	9	0.4 Nm
G 25 A 10	∅ 25	25 ^{+0.1} / _{-0.1}	∅ 10H7 ^{+0.015} / ₀	7	11	M4	8	9	0.4 Nm
G 30 A 10	∅ 25	30 ^{+0.1} / _{-0.1}	∅ 10H7 ^{+0.015} / ₀	8	14	M4	9	12	0.4 Nm

NOTE FOR THE INSTALLER: it is suggested to respect quotes inserting shaft on the coupling

Couplings dimensions

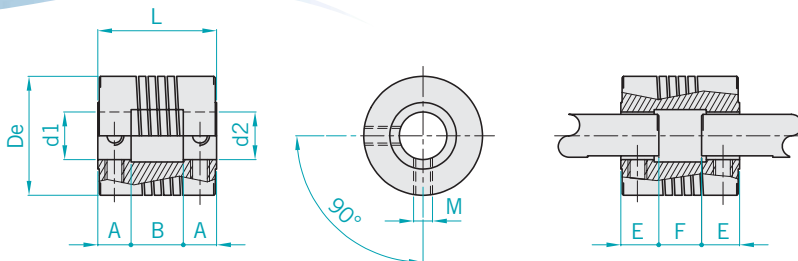

Construction data and specifications



Ordering Code	De	L	d1 = d2	A	B	M	E	F	Twisting moment
GS 02A 6	∅ 19.1	22 ^{+0.1} / _{-0.1}	∅ 6H7 ^{+0.012} / ₀			M3	6.3		0.9 Nm
GS 10A 8	∅ 19.1	22 ^{+0.1} / _{-0.1}	∅ 8H7 ^{+0.012} / ₀			M3	6.3		0.9 Nm
GS 16A 10	∅ 19.1	22 ^{+0.1} / _{-0.1}	∅ 10H7 ^{+0.012} / ₀			M3	6.3		0.9 Nm
GS 01A 8	∅ 19.1	28 ^{+0.1} / _{-0.1}	∅ 8 ^{+0.012} / ₀			M3	8		0.35 Nm
GS 11A 10	∅ 19.1	28 ^{+0.1} / _{-0.1}	∅ 10H7 ^{+0.012} / ₀			M3	8		0.35 Nm
GS 15A 10	∅ 19.1	47 ^{+0.1} / _{-0.1}	∅ 10H7 ^{+0.012} / ₀			M4	12.6		0.1.4 Nm
GS 23A 12	∅ 19.1	47 ^{+0.1} / _{-0.1}	∅ 12H7 ^{+0.012} / ₀			M4	12.6		1.4 Nm
GS 29A 6	∅ 25	32 ^{+0.1} / _{-0.1}	∅ 6H7 ^{+0.012} / ₀			M3	10		3 Nm
GS 24A 8	∅ 25	32 ^{+0.1} / _{-0.1}	∅ 8H7 ^{+0.012} / ₀			M3	10		3 Nm
GS 25A 10	∅ 25	32 ^{+0.1} / _{-0.1}	∅ 10H7 ^{+0.012} / ₀			M3	10		3 Nm

NOTE FOR THE INSTALLER: For a proper installation is suggested to insert shaft on the coupling respecting quotes

Eltra also produces a special coupling series designed especially for critic and heavy uses. On the table below are shown some special couplings available on stock. Different couplings available only on request.

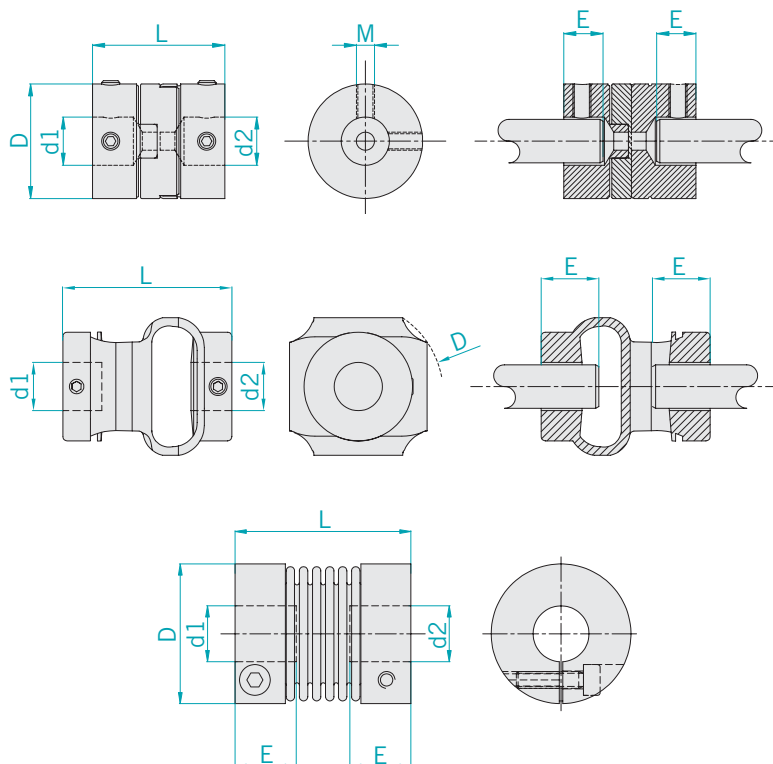

NPN and NPN OPEN COLLECTOR electronic

It is composed only by an NPN transistor and a pull-up resistor used to match the output voltage to the power supply when the transistor is quiescent. From the electrical point of view it is similar to TTL type logic and so it is considered compatible. If used correctly, it shows low saturation levels at 0 Vdc and close to 0 at the positive. It is proportionally influenced by the cable length, pulses frequency and by the load.

Please consider these specs for a proper use. The open collector variant is different for the lack of the pull-up resistor, freeing in such way the transistor collector from the tie of the encoder power supply allowing to obtain signals with different voltage.

NPN OPEN COLLECTOR

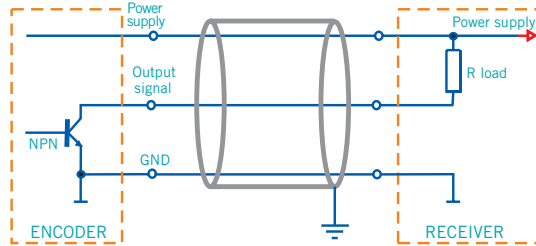

NPN

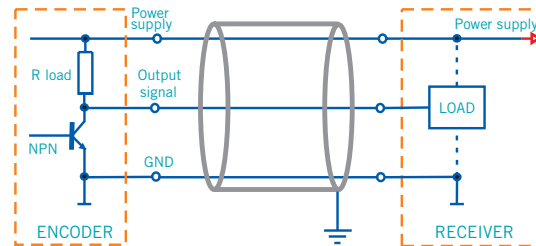

PNP OPEN COLLECTOR

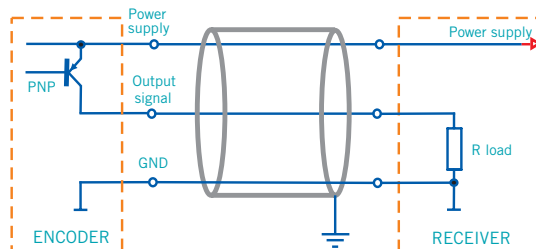

PNP

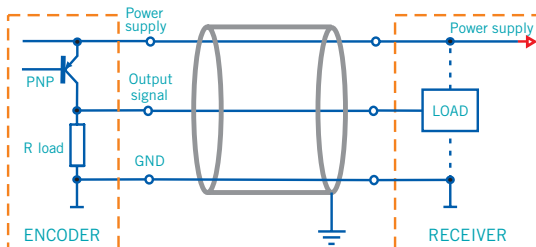

PNP and PNP OPEN COLLECTOR electronic

Main characteristics and limitations are the same as for NPN electronics. Main difference is the transistor, which is of PNP type and is constrained to the positive. The resistor, if present, is a pull-down one. Therefore, it is connected between the output and zero Vdc.

PUSH-PULL

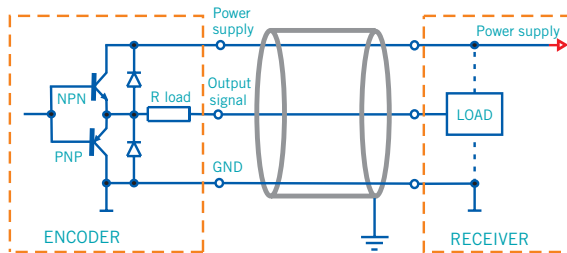

PUSH-PULL electronic

Electronic featuring high performances. NPN or PNP major limitations are caused by the resistor, which works with a much higher impedance than a transistor. To overcome this issue, push-pull electronic uses a complementary transistor, so the impedance is lower for commutation to positive and to zero. This solution increases frequency performances allowing longer cable connections and an optimal data transmission even at high working speed. Saturation signals are low but sometimes higher than in NPN and PNP electronics. Anyway, PUSH-PULL electronics is in any case indifferently applicable instead of NPN or PNP.

LINE DRIVER

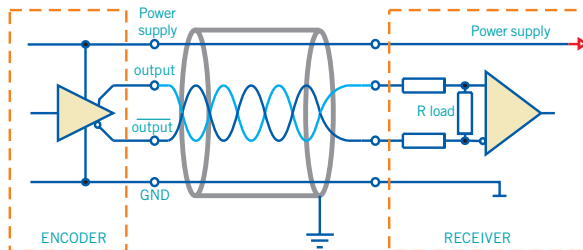

LINE DRIVER electronic

LINE DRIVER is used when operating environments are particularly exposed to electrical disturbances or when the encoder is quite far from the receiver system. Data transmission and receiving work on two complementary channels so disturbances are limited (they usually come from other cables or close machinery). These interferences are known as «common way disturbances» as their generation is due to a common point: the system mass. Instead, in LINE-DRIVER transmitted and received signals work in «differential» way. In other words, it works basing the communication on voltage differences between complementary channels. Therefore it is not effective to common way disturbances. This type of transmission is used in 5 Vdc systems and it is also known as RS422 compatible. It is available with power supplies up to 24 Vdc

PROTECTIONS

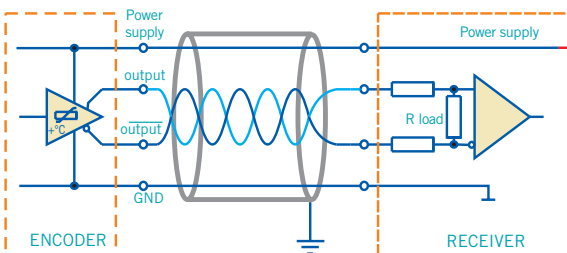
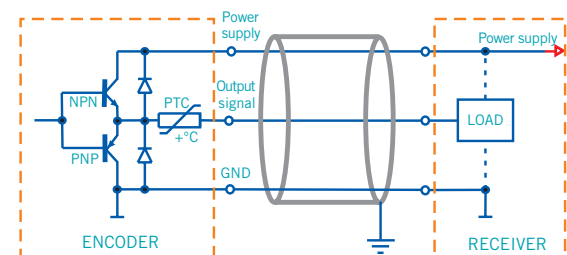

Protection for output stages

Two different kind of electronic protection against short circuits might be used: the passive one (using fuses, no linear resistors, etc.) and active one (using transistors). Eltra's encoders can be equipped with both type of protection against short circuits

Passive protection

Passive solution is the cheapest one. It is used to avoid accidental short circuits, which rarely happens. The component which carries out the protection is called PTC. It is a resistor that, if crossed by a voltage exceeding the supposed one, increases its resistance to limit electricity exceedance. Limitations of this kind of protection concern the low reacting speed, which may progressively stress the components under protection. Therefore, this protection is effective against a limited number of short circuits and it is available only for NPN, PNP, and PUSH-PULL electronics.

Active protection

This solution is based on a circuit integrated in the electronic output which constantly controls the temperature reached by the element to be protected. In this way, protection is very effective and the reacting speed very high. Moreover, it ensures a constant protection against repetitive and permanent short circuits, that is why is strongly suggested for heavy usages. It is available only for LINE-DRIVER and PUSH-PULL electronics.

NPN/NPN OPEN COLLECTOR TTL OR PUSH-PULL

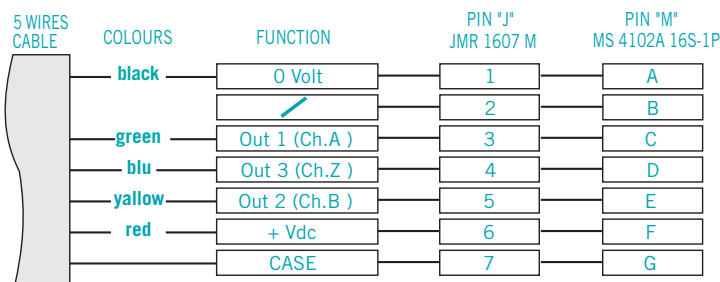

LINE DRIVER without ZERO

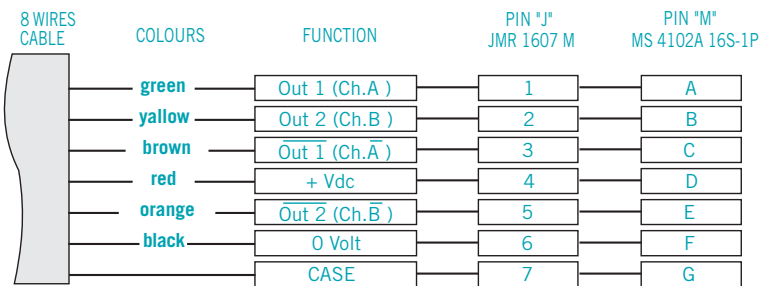

LINE DRIVER with ZERO

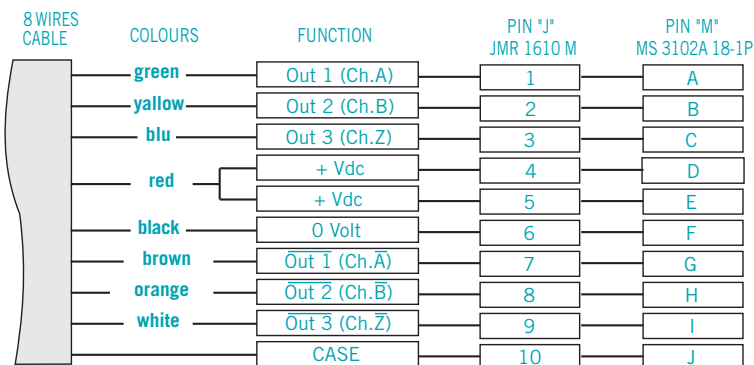

PRECAUTIONS AGAINST ELECTROSTATIC DICHARGES

Be sure the metallic connector is connected to the ground through a ring fixed to the screw of the connector itself (Fig. 1)

Fig. 1



Ground connect to the shield and the connector case (Fig. 2)

Fig. 2



For a better protection of the electronics against electrostatic discharges connect the metallic connector case to ground

Cable proper use

- Ensure a ground connection to the cable shield avoiding to connect it to the power ground.
- Keep the encoder cable (signal cable) to a proper distance from the power ones.
- Choose the cable's length according to installation requirements.
- Spread the cable avoiding spirals.

News

- Cable extensions and connectors could be designed on demand
- Testing on 100% of the production
- Antivibration wiring system
- **Contact us for further information**

Cables availability

POLES N°	CEI	IEC MARK	UL MARK	SHIELD	TYPE
5	CEI 20-22 II			FOIL	SEMIRIGID
		IEC 60332-1	UL-CSA	BRAID	FLEXABLE
	IEC 60332-1		UL-CSA	FOIL	SEMIRIGID
	CEI 20-22 II	IEC 60332.3		BRAID	SEMIRIGID
8	CEI 20-22 II			FOIL	SEMIRIGID
	CEI 20-22 II			BRAID	SEMIRIGID
		IEC 60332-1	UL-CSA	BRAID	FLEXABLE
		IEC 60332-1		FOIL	SEMIRIGID
	CEI 20-22 II	IEC 60332.3		BRAID	SEMIRIGID
10	CEI 20-22 II			BRAID	SEMIRIGID
12	CEI 20-22 II			FOIL	SEMIRIGID
16	CEI 20-22 II			FOIL	SEMIRIGID
32	CEI 20-22 II			FOIL	SEMIRIGID

NOTE: Please, directly contact our offices for non-standard cables availability

SV011T0305A

INCREMENTAL ENCODER CONNECTIONS



INSTALLATION AND OPERATION PRECAUTIONS



The encoder must be used with respect to its specifications. Encoder is a pulse generator and not a safety device



Assembling and installing personnel must be qualified and carefully follow instructions of technical manual.



Don't expose the device to stress or impacts in order to ensure the correct working otherwise the warranty expires



Make sure that the mechanical coupling of the encoder shaft is designed with the appropriate elastic couplings, especially in the case of accentuated axial or radial movements



Make sure that the environment of use is free of corrosive agents (acids, etc.) or substances that are not compatible with the device



Check the ground connection of the device if it is not possible to provide additional external connection.



Before putting it in operation, verify the voltage range applicable to the device and protect it from exceeding the stated technical specifications.



Connect power supply and signals cables in order to avoid capacitive or inductive interferences that may cause malfunction of the device.



Cable wiring must be carried out in a POWER-OFF condition



For safety reasons, we strongly recommend to avoid any mechanical or electrical modification. In that case, they will void the warranty

Main product warranty terms

Replacements or repairs whether under the warranty or at the customer's expense must be performed in the service department of Eltra Srl or by explicitly authorized personnel. Before sending material for repairing, you must obtain an RGA number from our sales office. During the repair process in our service department, Eltra srl will be authorized to remove all parts that the customer added to the product. Any malfunction due to a failure to observe these usage and installation precautions will lead to the warranty voiding. Repairs will not extend the product warranty. We also exclude compensation for any type of damage or injury due to the use, or suspension of use, of the transducer.

Note: for additional information, refer to the sale terms on our website, www.eltra.it, or call our office.